

3A, 20V - 200V Schottky Barrier Surface Mount Rectifier

FEATURES

- Low power loss, high efficiency
- Ideal for automated placement
- Guard ring for overvoltage protection
- High surge current capability
- Moisture sensitivity level: level 1, per J-STD-020
- RoHS Compliant
- Halogen-free according to IEC 61249-2-21

APPLICATIONS

- Switching mode power supply (SMPS)
- Adapters
- Lighting application
- Converter

MECHANICAL DATA

- Case: DO-214AA (SMB)
- Molding compound meets UL 94V-0 flammability rating
- Terminal: Matte tin plated leads, solderable per J-STD-002
- Meet JESD 201 class 2 whisker test
- Polarity: Indicated by cathode band
- Weight: 0.100g (approximately)

KEY PARAMETERS		
PARAMETER	VALUE	UNIT
I_F	3	A
V_{RRM}	20 - 200	V
I_{FSM}	70	A
T_{JMAX}	125, 150	°C
Package	DO-214AA (SMB)	
Configuration	Single die	



DO-214AA (SMB)



ABSOLUTE MAXIMUM RATINGS ($T_A = 25^\circ\text{C}$ unless otherwise noted)											
PARAMETER	SYMBOL	SK 32B	SK 33B	SK 34B	SK 35B	SK 36B	SK 39B	SK 310B	SK 315B	SK 320B	UNIT
Marking code on the device		SK 32B	SK 33B	SK 34B	SK 35B	SK 36B	SK 39B	SK 310B	SK 315B	SK 320B	
Repetitive peak reverse voltage	V_{RRM}	20	30	40	50	60	90	100	150	200	V
Reverse voltage, total rms value	$V_{R(RMS)}$	14	21	28	35	42	63	70	105	140	V
Forward current	I_F	3									A
Surge peak forward current, 8.3ms single half sine-wave superimposed on rated load	I_{FSM}	70									A
Critical rate of rise of off-state voltage	dV/dt	10,000									V/ μs
Junction temperature	T_J	- 55 to +125				- 55 to +150					°C
Storage temperature	T_{STG}	- 55 to +150									°C

THERMAL PERFORMANCE			
PARAMETER	SYMBOL	TYP	UNIT
Junction-to-lead thermal resistance	$R_{\theta JL}$	23	°C/W
Junction-to-ambient thermal resistance	$R_{\theta JA}$	63	°C/W

ELECTRICAL SPECIFICATIONS (TA = 25°C unless otherwise noted)						
PARAMETER		CONDITIONS	SYMBOL	TYP	MAX	UNIT
Forward voltage ⁽¹⁾	SK32B	$I_F = 3A, T_J = 25^\circ C$	V_F	-	0.50	V
	SK33B			-	0.75	V
	SK34B			-	0.85	V
	SK35B			-	0.95	V
	SK36B			-	-	-
	SK39B			-	-	-
	SK310B			-	-	-
	SK315B			-	-	-
	SK320B			-	-	-
Reverse current @ rated V_R ⁽²⁾	SK32B	$T_J = 25^\circ C$	I_R	-	500	μA
	SK33B			-	100	μA
	SK34B			-	-	-
	SK35B			-	-	-
	SK36B			-	-	-
	SK39B			-	-	-
	SK310B			-	-	-
	SK315B			-	-	-
	SK320B			-	-	-
	SK32B	$T_J = 100^\circ C$	I_R	-	10	mA
	SK33B			-	5	mA
	SK34B			-	-	-
	SK35B			-	-	-
	SK36B			-	-	-
	SK39B			-	-	-
	SK310B			-	-	-
	SK315B			-	-	-
	SK320B			-	-	-
SK32B	$T_J = 125^\circ C$	I_R	-	-	mA	
SK33B			-	-	mA	
SK34B			-	-	-	
SK35B			-	-	-	
SK36B			-	-	-	
SK39B			-	-	-	
SK310B			-	2	mA	

Notes:

1. Pulse test with PW = 0.3ms
2. Pulse test with PW = 30ms

ORDERING INFORMATION

ORDERING CODE⁽¹⁾	PACKAGE	PACKING
SK3xB	DO-214AA (SMB)	3,000 / Tape & Reel

Notes:

1. "x" defines voltage from 20V(SK32B) to 200V(SK320B)

CHARACTERISTICS CURVES

($T_A = 25^\circ\text{C}$ unless otherwise noted)

Fig.1 Forward Current Derating Curve

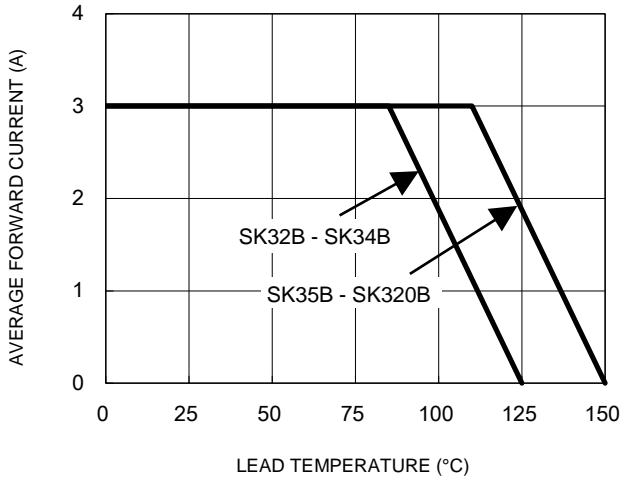

Fig.2 Typical Junction Capacitance

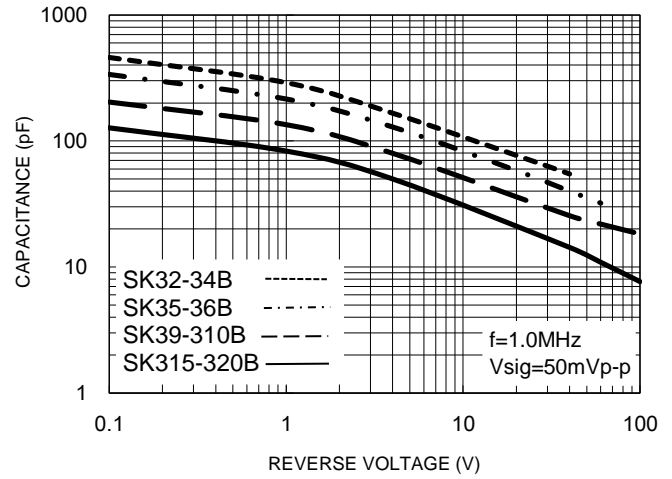

Fig.3 Typical Reverse Characteristics

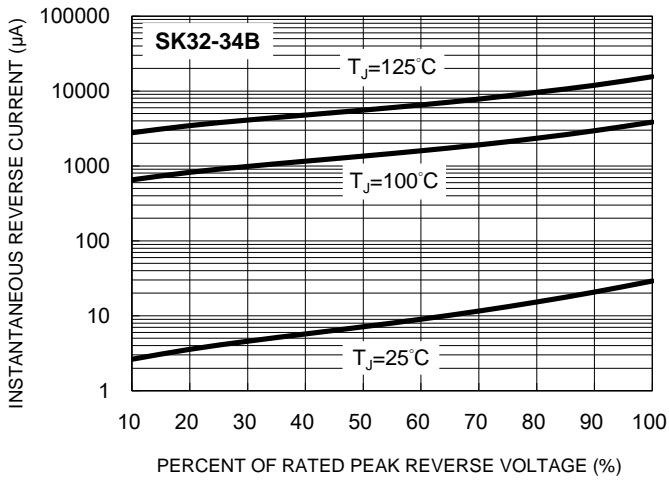

Fig.4 Typical Forward Characteristics

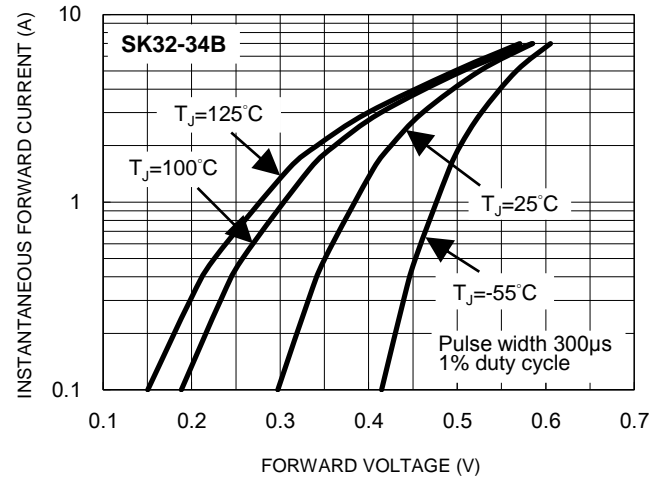

Fig.5 Typical Reverse Characteristics

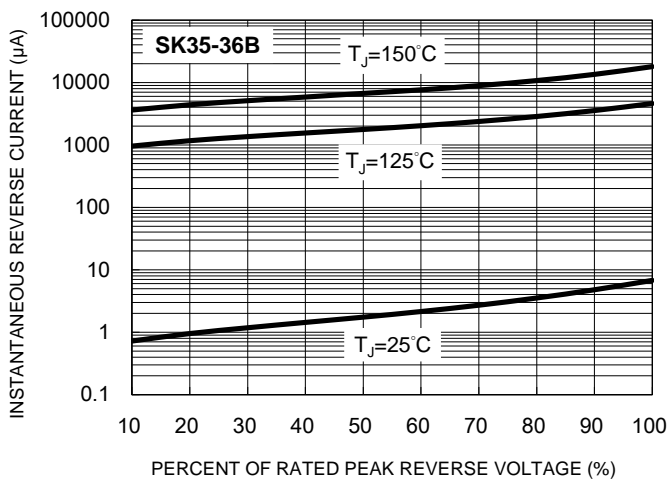
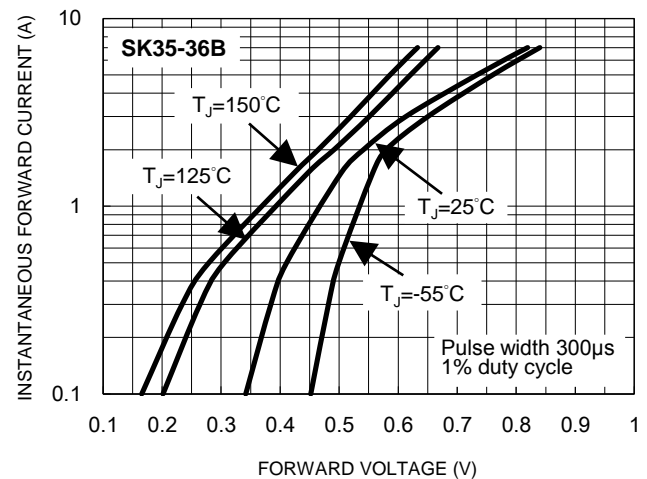

Fig.6 Typical Forward Characteristics



CHARACTERISTICS CURVES

($T_A = 25^\circ\text{C}$ unless otherwise noted)

Fig.7 Typical Reverse Characteristics

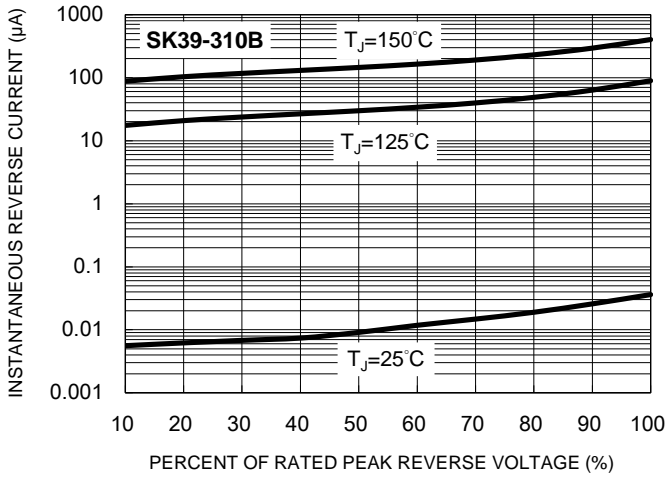

Fig.8 Typical Forward Characteristics

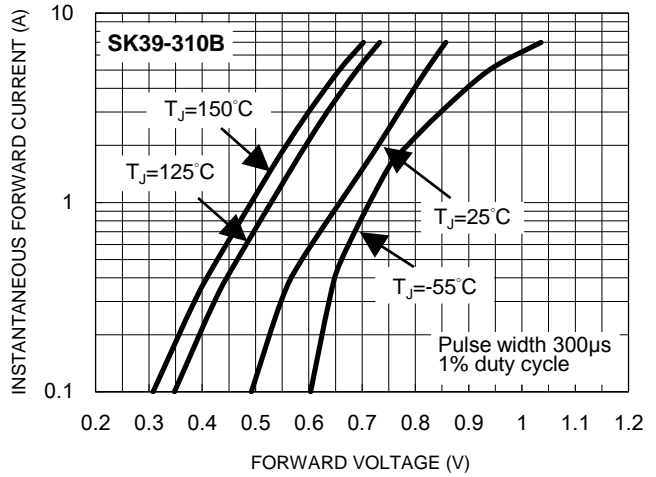

Fig.9 Typical Reverse Characteristics

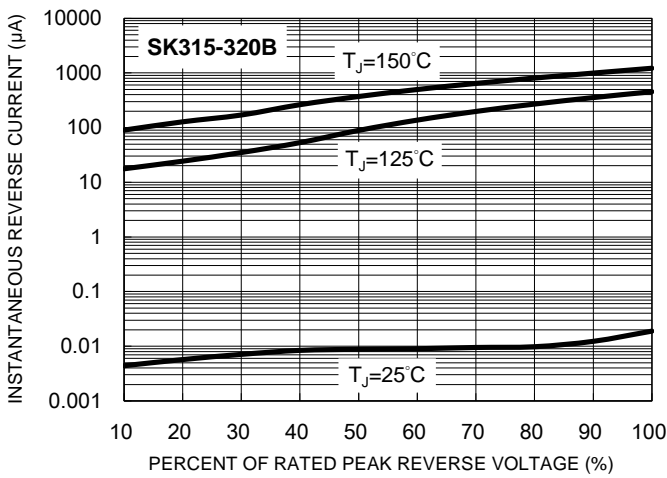

Fig.10 Typical Forward Characteristics

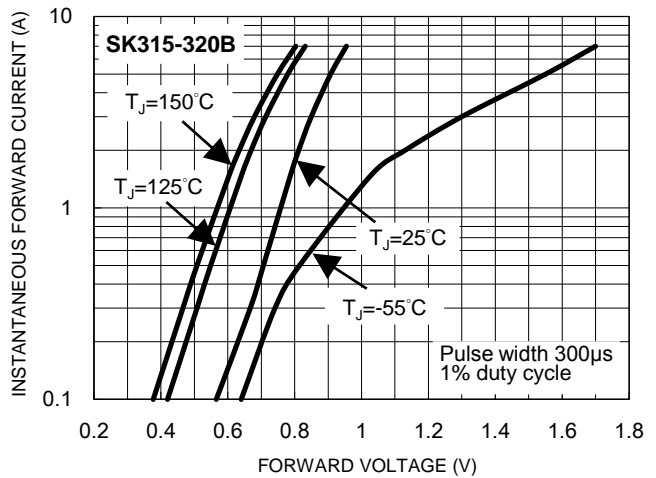
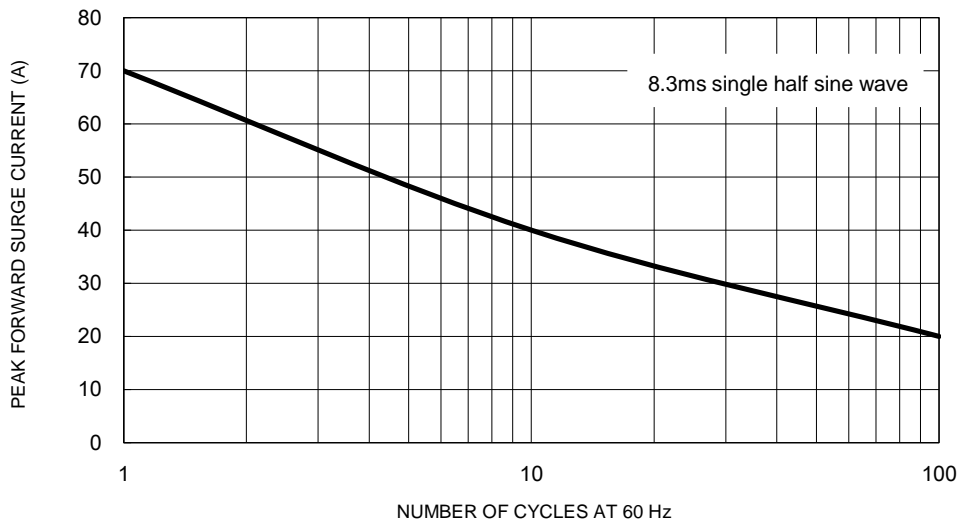

Fig.11 Maximum Non-Repetitive Forward Surge Current



CHARACTERISTICS CURVES

($T_A = 25^\circ\text{C}$ unless otherwise noted)

Fig.12 Typical Transient Thermal Characteristics

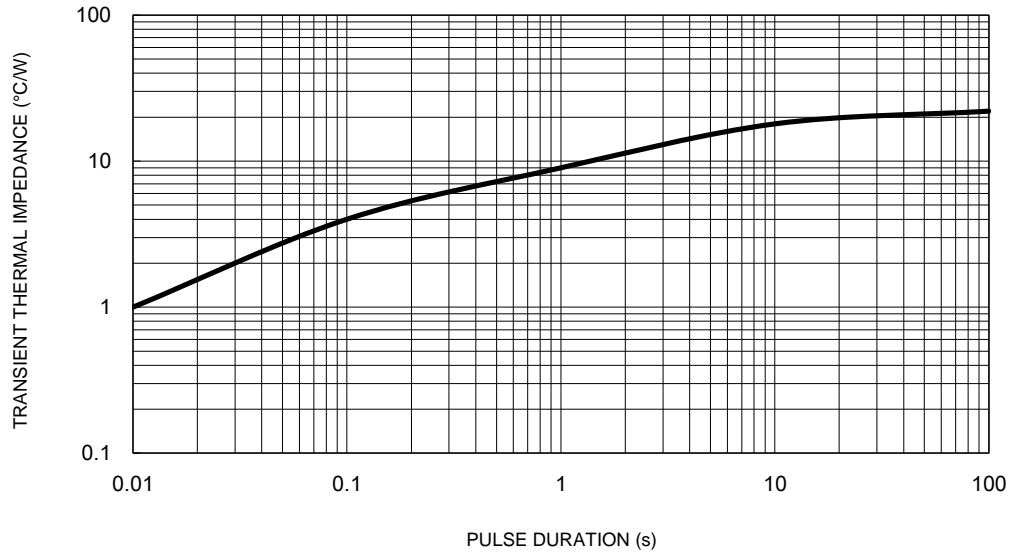

PACKAGE OUTLINE DIMENSIONS

DO-214AA (SMB)

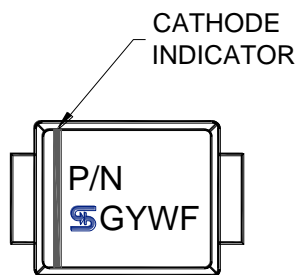
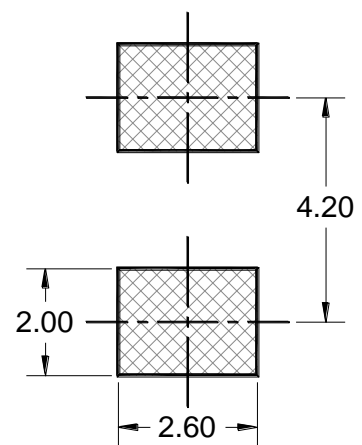
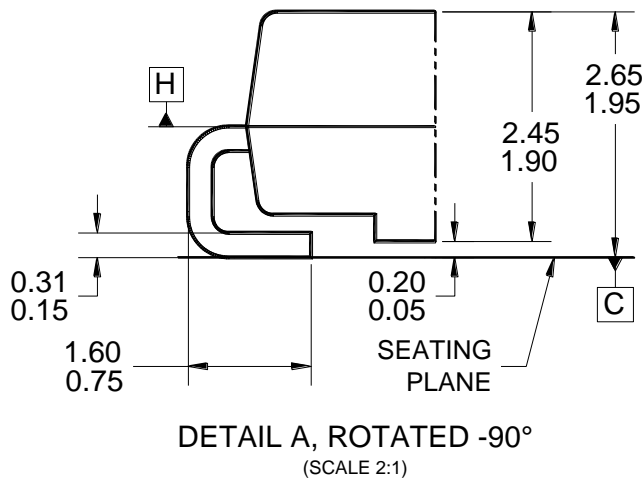
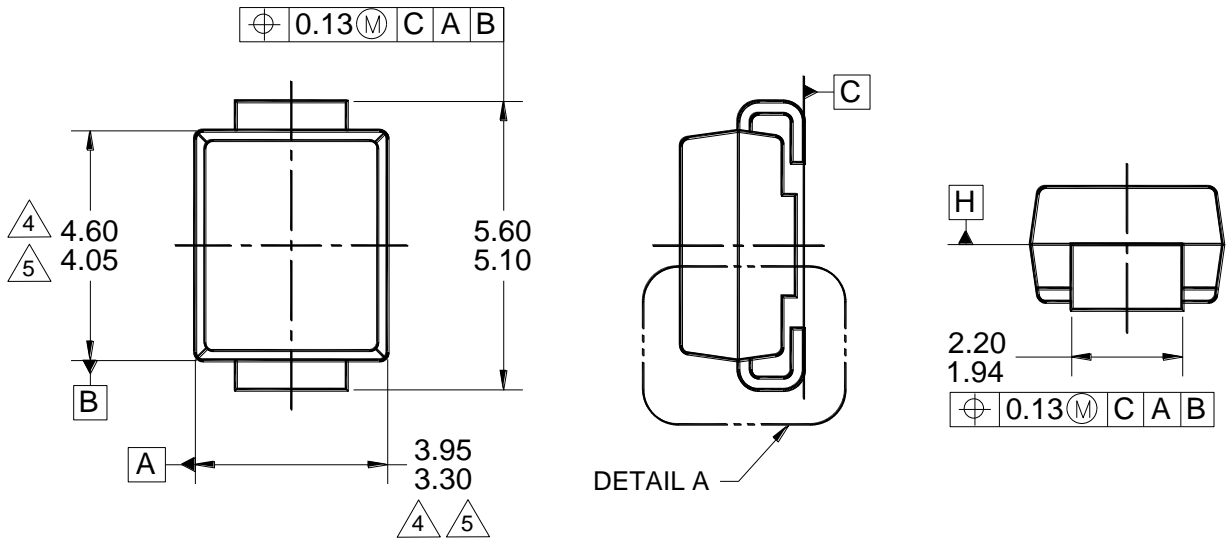

MARKING DIAGRAM

P/N = MARKING CODE
G = GREEN COMPOUND
YW = DATE CODE
F = FACTORY CODE

NOTES: UNLESS OTHERWISE SPECIFIED

1. ALL DIMENSIONS ARE IN MILLIMETERS.
2. DIMENSIONING AND TOLERANCING PER ASME Y14.5M-1994.
3. PACKAGE OUTLINE REFERENCE: JEDEC DO-214, VARIATION AA, ISSUE D.
4. MOLDED PLASTIC BODY DIMENSIONS DO NOT INCLUDE MOLD FLASH.
5. MOLDED PLASTIC BODY LATERAL DIMENSIONS TO BE DETERMINED AT DATUM PLANE H.
6. DWG NO. REF: HQ2SD07-DO214SMB-035 REV A.